

Series 7230



INSTALLATION & OPERATING MANUAL  
CONTINUOUS LEVEL CONTROLS

# 7230 HT Series Digital Probe

MAGNETOSTRICTIVE LEVEL SYSTEM



**ABSOLUTE PROCESS CONTROL  
KNOW WHERE YOU ARE... REGARDLESS**



# 7230 Ht Series Digital Probe Installation & Operating Manual

## Table of Contents

Section 1 - 7230 Series HT Digital Probe .....	2
1.1 - Part Numbering and Accessories.....	3
1.2 - Mounting Conditions.....	4
1.3 - Unpacking.....	4
1.4 - Installation of a Rigid Probe.....	4
1.5 - Temperature Sensor Locations.....	5
1.6 - Off-Set Procedure.....	5
1.7 - 7231 Modbus Set Up.....	6
1.8- 7231 Wiring.....	6
Section 2 - 7321- Modbus Configuration.....	7
2.1 - Modbus Master Operation.....	7
2.2 - Master Slave Configuration.....	7
2.3 - Modbus Slave Operation.....	7
2.4 - Baud Rate.....	8
2.5 - Jumper Settings.....	9
2.6 - Data Points.....	10
2.7 - Error Codes.....	10
2.8 - Scaling.....	10
2.9 - Holding and Input registers.....	10
2.10 - Enron Modbus.....	10
2.11 - Maximum registers.....	10
2.12 - Examples of Accessing Data in the 7231 HT.....	10
2.13 - Byte Ordering.....	11
2.14 - Modbus Map.....	11
2.15 - Modbus Registers.....	11
2.16 - Floating Point Formats.....	12
2.17 - Status Bit Definitions.....	17
Section 3 - 7235 ASCII Digital Set Up and Wiring.....	17
3.1 - 7235 Digital Configuration.....	17
3.2 - 7235 Data Format.....	17
Section 4 - Basic Trouble Shooting 7230 HT Series Magnetostrictive Probes....	18
Section 5 - Equipment Return.....	22
Section 6 - Warranty.....	22

# Section 1 - 7230 Series HT Digital Probe

The 7230 Series HT Digital Probe is a new magnetostrictive level measurement system from AMETEK APT for the up-stream Oil & Gas Industry and high temperature applications that require multiple level and temperature measurements.

Magnetostrictive level measurement technology has the capability of providing the highest accuracy of any of the most popular level technologies that are currently offered in today's market. The 7230 Series is no exception, as it exceeds the high accuracy of the proven 7330 Series with an impressive accuracy of 0.01% of measured span.

The 7230 HT Digital Stik is a level measurement solution that provides both total level, interface level and up to 5 temperature readings that requires only one process connection. The 7230 Series has multiple output options, a digital ASCII interface and an RS-485 Modbus RTU digital output with an optional analog interface. The 7230 Series is approved as Explosion Proof (without Intrinsic Safety Barriers) for Class I, Div. 1, and Zone 1 hazardous area installations.

The advantages of magnetostrictive technology

include high accuracy and reliable level measurement capabilities that are completely independent of changes in the process material's electrical characteristics and densities. Hydrocarbon based condensates have a predictable range of specific gravity that are well within the range of floats that are part of this product offering. There is no calibration required to set up the probe. Variations in hydrocarbon make up will not cause any level measurement errors.

A choice of two communication protocols are available. The 7231 HT has a patented Modbus module that provide 12 Register Maps using 16 or 32 bits, with either Modbus RTU or ASCII transmission. In addition, there is an optional Analog output converter available for 4-20mA applications. The 7235 HT has a proprietary ASCII digital output and would be recommended for OEM use. The new sensor has an explosion proof approval for use in Class I, Div. I, Group A, B, C, and D hazardous area installations.

The advantages of magnetostrictive technology include high accuracy and repeatability, plus reliable level measurement capabilities that are completely independent of the process materials electrical characteristics. The standard float is suitable for most liquids with a minimum density of 0.5 specific gravity.

Magnetostrictive Principle

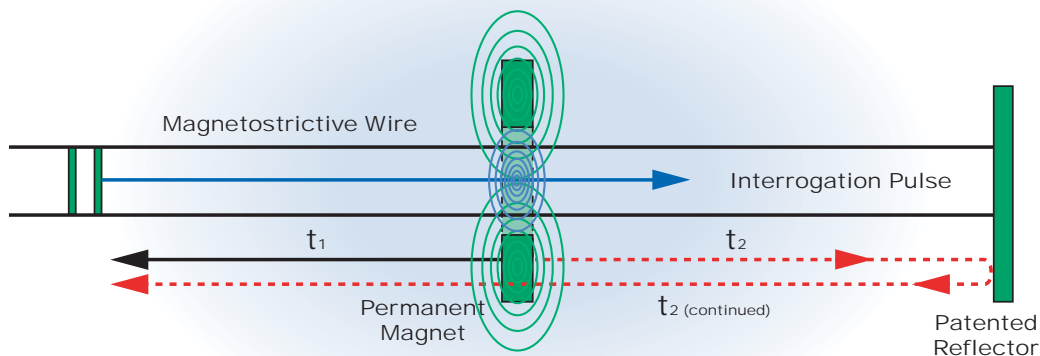

1. A high current interrogational pulse creates an electromagnetic field along the magnetostrictive wire.
2. Interaction with the permanent magnet creates a torsional strain pulse that travels up ( $t_1$ ) and down ( $t_2$ ) the wire.
3. The torsional strain pulse travels up the wire to a small pick up sensor at the top of the transducer. The pulse traveling down the wire is reflected and continues up the wire to be sensed by the same pick up sensor.
4. The time between the pulse ( $t_1$ ) and the pulse ( $t_2$ ) is used to determine the level.

# 1.1 - Part Numbering and Accessories

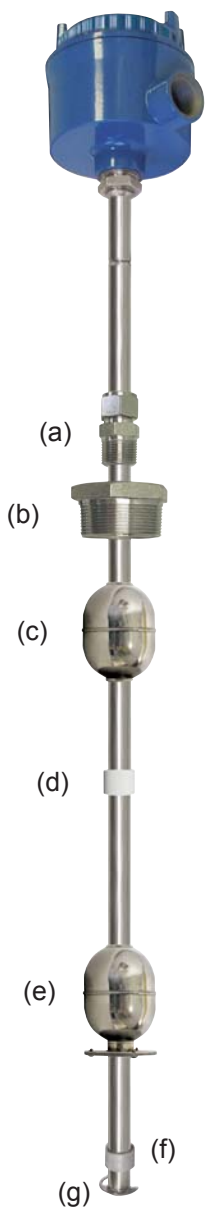
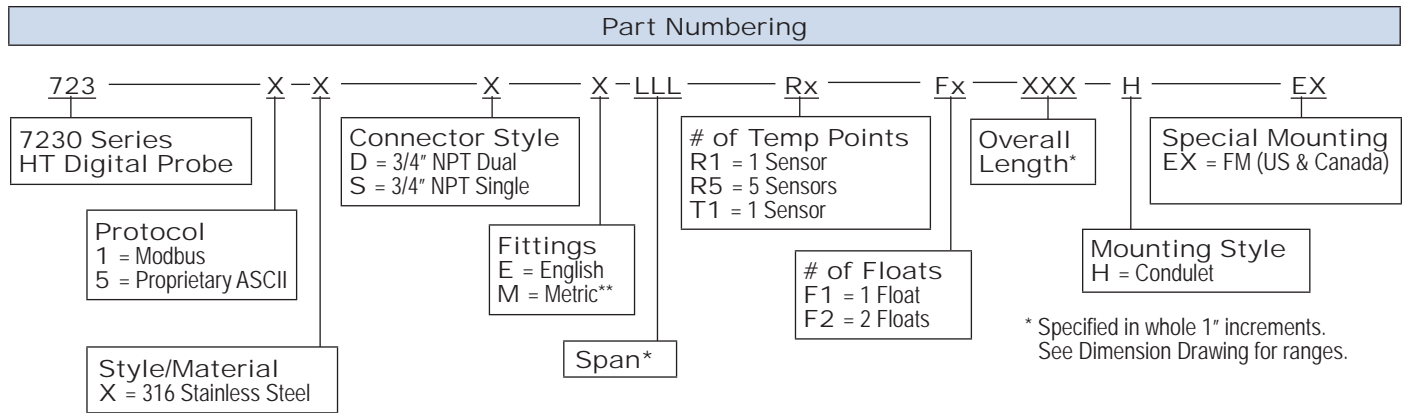

Specifications		Approvals
Output Signal/Protocol	Level, Interface and Temperature 7231: RS-485, Modbus RTU 7235: TTL, Proprietary	FM (US and Canada) XP Class I, Div I, Group A, B, C, D, T4 DIP Class II, III, Group E, F, G, T4 
Data	7231: Signed, Long, Binary 7235: ASCII	
Range Temp.	-40°F to 257°F Process -40°F to 158°F Ambient	
Pressure Rating, Wetted Parts	316SS Probe: 1000 psi max. Floats: Dependent. Consult Factory.	
Wetted Parts	316LSS	
Probe Length	Up to 24 foot, 21" to 288"	
Accuracy	0.01% of Span	
Resolution	7231: 0.01", 0.1 °C 7235: 0.0001", 0.1 °C	
Power Supply	7231: 10 to 30 VDC 40mA @ 30 VDC max. 26mA @ 24 VDC Typical 7235: 5 VDC, +/-10% Typical 3.7 VDC min. 17mA max.	
Enclosure Type	Type 4/4X IP66	
Null Zone	9.25"	
Dead Band	2.75"	

Specifications are subject to change without notice. Patented.

## Accessories (Purchased separately)

- (a) Compression Fitting, 5/8" to 3/4" NPT, Stainless Steel.
- (b) Reducer Bushing, 2" x 3/4" NPT.
- (c) Level Float, 2", 316 Stainless Steel.
- (d) Float Spacer, PVDF (Kynar®)  
Kynar® is a Registered Trademark of Atofina Chemicals, Inc..
- (e) Interface Float, optional, 2", 316 Stainless Steel.
- (f) Dead Band Spacer, 316 Stainless Steel.
- (g) E-Clip, 316 Stainless Steel.
- (h) Two piece Halar® Foot and End Cap, ECTFE  
Halar® is a Registered Trademark of Ausimont USA, Inc.



Figure 1.1

## 1.2 - Mounting Conditions

1. The 7230 Series HT Digital Probe level system is designed for industrial applications, but should be mounted in a location as free as possible from vibration, corrosive atmospheres, or any possibility of mechanical damage.
2. Mount the probe in a reasonably accessible location, away from agitation.
3. Process temperature is between -40°F and 257°F (-40°C to 125°C).
4. Mount the probe perpendicular with gravity so the float moves freely along the probe.

### CAUTION

When installing probes, do not bend rigid probes. Permanent damage may result. *(Consult factory about a telescoping support to assist with the installation of 20-24 ft. probes)* Rigid probes, longer than 10 ft., need to be supported at both ends while handling. Remove the Caution Tag before installing. Probes are built with the electronic circuits sealed inside the tube at the factory. Do not attempt to open or weld on the tube.

## 1.3 - Unpacking

Carefully remove the contents of the shipping carton and check each item against the packing list before destroying the packing materials. Any damage must be reported to the shipping company. If you do not receive all of the parts on the packing slip, contact Ametek at 800-635-0289 (US and Canada) or 248-435-0700 (International).

Most rigid probes are shipped in a Tube. To remove the metal end cap, use a large, flat blade screw driver or a metal rod and tap on the inner edge of the cap until it pivots. Grab the cap and pull it out. Use caution as the edge of the metal cap may be sharp.

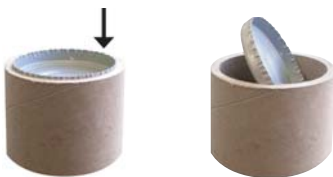

If you have an RMA warranty claim, pack the probe in a shipping tube or with stiff reinforcement to prevent the probe from being bent in transit.

## 1.4 - Installation of a Rigid Probe

The D style connector with dual 3/4 NPT thread does not require a compression fitting for installation. The S style connector will require a compression fitting, which is mounted below the tube crimp on the probe to insure a proper seal.

Assemble the Probe  
(See Figure 1.1 on pg. 3)

1. Mount the Compression Fitting (a) if the Style S connector is being used.
2. Install the bushing if it is used.
3. If the probe has 1 float, (F1), slide the Level Float (b) or Interface Float (d) onto the probe. If the probe has 2 floats, (F2), slide the Level Float (b) onto the probe, followed by the Float Spacer (c), and then the Interface Float (d). The magnet is located in the middle of the 316 SS Level Float, so orientation does not matter. The 316SS Interface Float must be positioned with the plates at the bottom.
4. Slide the Dead Band Spacer (e) onto the probe.
5. Capture these parts with either a retainer E-Clip (f) or the End Cap (g).
6. Verify that the floats and spacers move smoothly up and down the probe.

Insert the Probe

See Figure 1.2 on page 5

7. Insert the foot of the probe into the tank. **Do not allow the float(s) to drop suddenly since this could damage the float or retainer at foot of the probe.**
8. Thread the bushing into the tank, flange, or bung/riser. Properly fasten the bushing and flange.
9. Thread the compression fitting or probe into the bushing or flange.
10. Hand tighten. To insure Compression Fitting is sealed, turn it 1 1/4 turns after hand tightening.
11. Make final check to see that all fasteners are in proper position and that the probe is securely tightened.

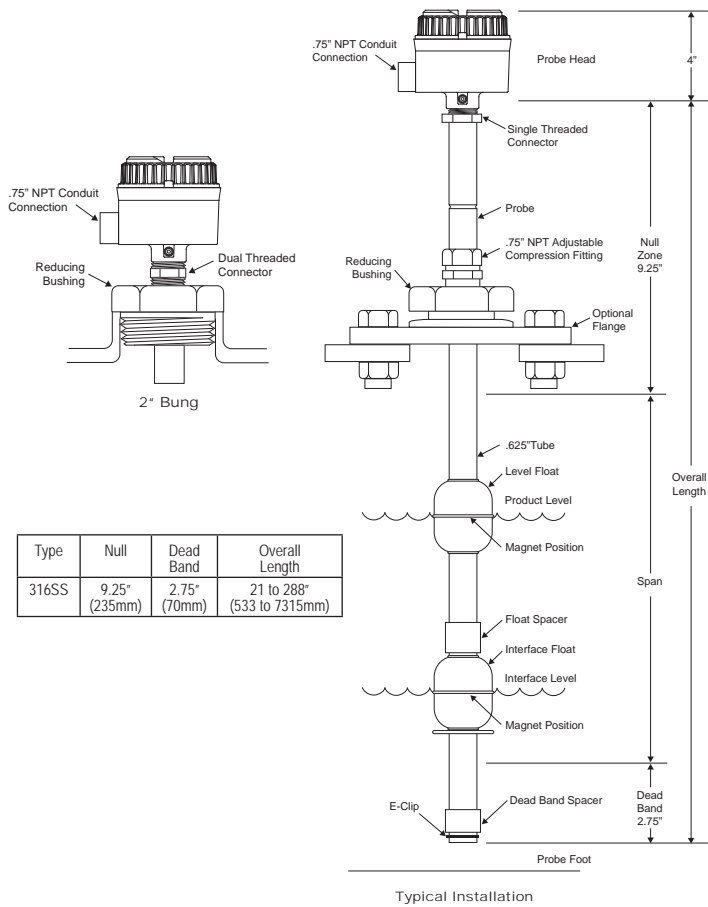

Figure 1.2  
(Drawing not to scale.)

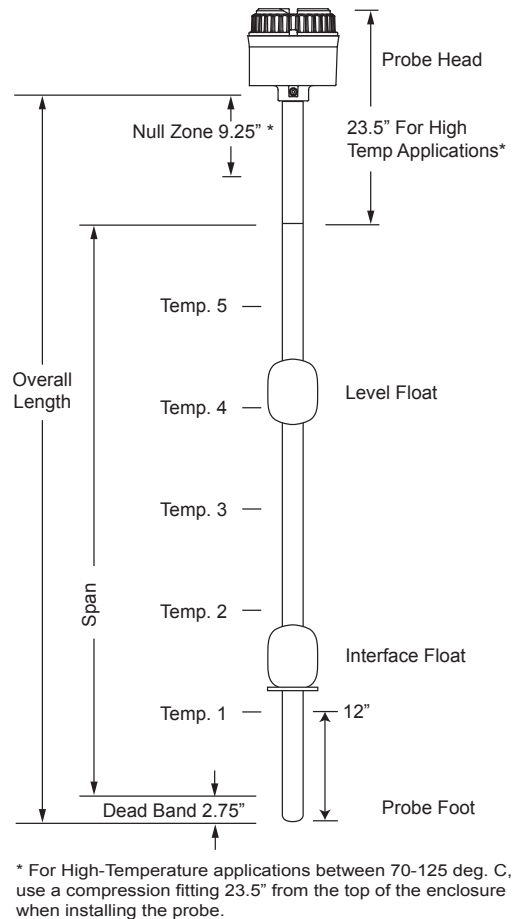

Figure 1.3  
(Drawing not to scale.)

## 1.5 - Temperature Sensor Locations

The 7230 Series probes come with 1 or 5 temperature sensors. See Figure 3. The physical location of the temperature sensors are based upon the probe span.

### Single Temp Sensors

R1 probes have the temperature sensor located 12\"/>

### Multiple Temp Sensors

R5 probes have the first temperature sensor located 12\"/>

5

## 1.6 - Off-Set Procedure

Analog probes require you to assign a value to the incremental change to the span from 4mA to 20mA. The 7230 Series is a digital probe with high resolution and repeatability, but the overall accuracy is also dependant upon the installation set-up. The 7231/7235 position output is the actual position of the float magnet on the active area of the magnetostrictive wave guide. While there is no calibration of the probe, you must provide a reference point for the level measurement. The probe output indicates the position of the magnet on the probe, the instrument does not know where it is located in the tank. The measurement of a level change is extremely accurate, but to insure an accurate absolute level measurement, the level may require correction.

1. Measure the level of the tank manually.
2. Install the probe and compare the sensor's level position with the manual measurement.
3. If necessary, calculate the "offset" (correction factor and apply this to the probe output in the controller.

## 1.7 - 7231 Modbus Set Up

The 7231 uses the Modbus protocol for communicating with a PC or devices such as a programmable logic controller. Modbus is a master-slave protocol that is openly published. Many PC programs currently exist for communicating with Modbus supported devices. The 7231 supports both RTU and ASCII transmission modes over RS-485.

## 1.8 - 7231 Wiring

Wiring for the 7231 HT Modbus probe is illustrated in Figure 4 and Installation Drawing E0242100, Sheet 1. The probe is approved for hazardous locations.

### CAUTION

Since the probe has an explosion proof approval for hazardous locations, it is important to use the appropriated conduit and seals. All installations should comply with the latest edition of The National Electrical Code (ANSI/NFPA 70) and the Canadian Electrical Code (CEC).

As many as 32 Modbus devices may be multi-dropped on the same bus. A twisted pair is used to connect the 7231 to a host, such as a PC with a RS-485 converter or PC card. It is recommended that the twisted pair be shielded and at least 22 AWG. The shield should be connected to common only at one end.

**NOTE:** If the RS-485 bus already has terminating resistors installed, the jumper JP1 on the motherboard must be set to position 2-3. This will remove the built-in terminating resistor that is connected by default.

### CAUTION

Do not remove the explosion proof cover in a hazardous area. You must make certain that the power is locked out and the area is safe. When servicing is completed, the cover must be replaced and secured with the set screw before power is applied to the instrument.

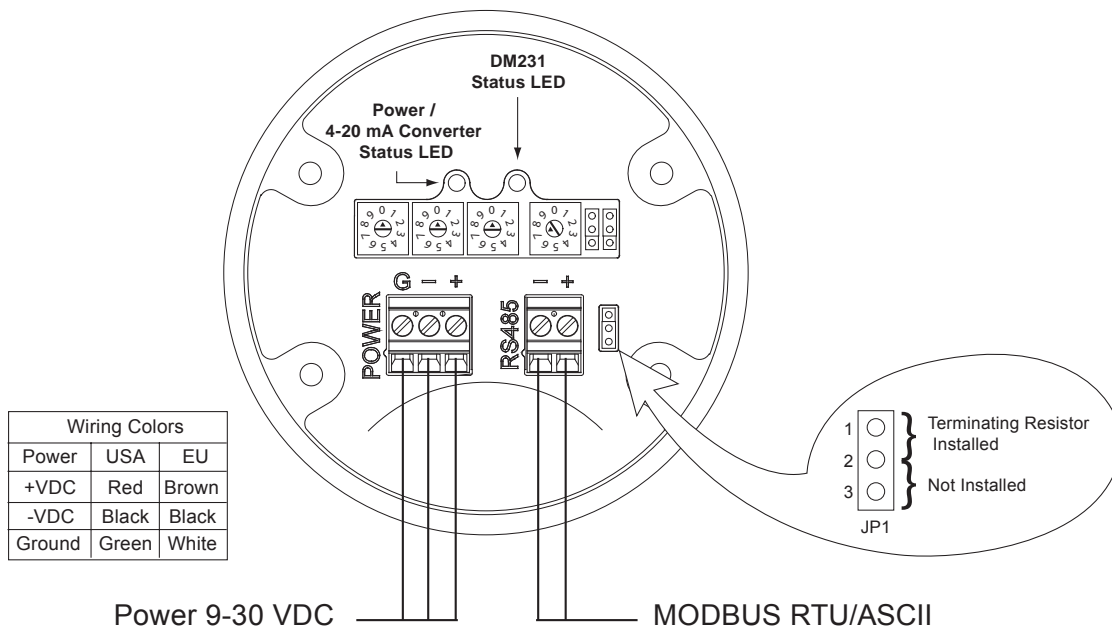

Figure 1.4 - 7231 Wiring  
(Switches and jumpers shown in the default positions.)



## Section 2 - 7231- Modbus Configuration

The 7231 HT has 2 modes: it can act as a Modbus slave, responding to data requests from a Modbus master, or it can act as a Modbus master, used for interfacing to an optional Modbus to 4-20 mA converter. The mode is determined by the Baud Rate switch (figure 4.1 on pg. 9). Position 0 configures the 7231 HT as a Modbus Master. Positions 1- 9 configure the 7231 HT as a Modbus Slave, and also sets the baud rate at which it will communicate with the master.

The default settings for the 7231 are Modbus Slave mode, 19,200 baud, RTU, 8 data bits, no parity and 1 stop bit. The default address switches are set to 000 which corresponds to an address of 001. Note all other address settings correspond to the value of the switches and only switch setting 000 is unique and is equivalent to 001.

### 2.1 - Modbus Master Operation

When configured as a Modbus master, all the other switches and jumpers will have no effect. In this case, the communication parameters are fixed at 9600 baud,

8 data bits, no parity and 2 stop bits. The 7231 HT connects to PC Windows based software which is used to set the configuration from Modbus to the analog converter to drive 4-20mA outputs. (Refer to ADAM - 4024 Setup Procedure, Application Note Z332, supplied on CD). The PC software shows the current values for the data points (product, average temperature, etc.) It also allows the user to select one of the variables to represent a 4-20mA analog output. After selecting the desired variable, the user sets the LRV (Lower Range Value) and URV (Upper Range Value), which determines the output current. 4 channels are available for outputs, (see screen below).

### 2.2 - Master Slave Configuration

The mode (Modbus master or slave) is controlled by the baud rate switch. Settings 1 – 9 will configure the 7231 HT as a Modbus slave and set the baud rate. All other configuration variables are set according to the instructions below (see figure 2.1 on pg. 9).

Screen shot of PC configuration program used to configure the 7231 HT when used with ADAM module.

7231 Setup

File Options Help

Analog Output 1

Assignment [ ]

URV (20mA) 0

LRV (4mA) 0

Analog Value [ ]

Analog Output 2

Assignment [ ]

URV (20mA) 0

LRV (4mA) 0

Analog Value [ ]

Analog Output 3

Assignment [ ]

URV (20mA) 0

LRV (4mA) 0

Analog Value [ ]

Analog Output 4

Assignment [ ]

URV (20mA) 0

LRV (4mA) 0

Analog Value [ ]

Update

Communications Status: Disconnected

DM231 Readings

Product [ ] inches

Interface [ ] inches

Avg Temperature [ ] deg C

Temperature 1 [ ] deg C

Temperature 2 [ ] deg C

Temperature 3 [ ] deg C

Temperature 4 [ ] deg C

Temperature 5 [ ] deg C

## 2.3 - Modbus Slave Operation

When configured as slave, the 7231 HT responds to requests for data from a Modbus master. The data available is the product, interface, total covered temperature, product temperature, interface temperature, span (probe length), max temperature, and the individual values of the 5 temperature sensors from the probe as well as the status of the probe.

The 7231 HT is capable of communicating using the Modbus RTU or ASCII format. The format is selected by the on board jumper JP2. The serial communication parameters are selected by the on board jumper JP3. The baud rate and Modbus device number are selected by on board switches. Refer to the table and fig. 2.1 on pg. 9 for the jumper settings.

Individual data items (product, average temperature, etc.) are obtained by issuing a Modbus request with a specific register number, as per the Modbus protocol specification. Multiple values can be obtained by specifying a starting register and the number of registers desired.

The data returned from a Modbus request can be in many formats: 16 bit integer, 32 bit integer (long), or floating point. The 7231 HT has a unique feature which allows the user to specify the data format desired by the selecting the correct register. For example, the value for the product reading can be obtained as an integer (16 bits), a long word (32 bits), or a floating point value (32 bits) by simply choosing different registers.

In addition to the length of the data, the order of the bytes in the returned data must be known by the Modbus master in order to assemble the data correctly. The 7231 HT allows for all byte ordering combinations by specification of the correct register number.

In traditional Modbus, 1 register represented 16 bits of data. To obtain a 32 bit value, the master requested 2 registers to get the 32 bits. A variant of Modbus called Enron Modbus allows for 32 bits of data to be returned with 1 register request. The 7231 HT will work with either type of Modbus master. Again, the format type is controlled by the register number requested.

## 2.4 - Baud Rate

The baud rate for a Modbus slave configuration is determined by the Baud rate switch, summarized in the following table:

Switch position	Baud (in bps)
0	Sets 7231 HT as a Modbus master
1	600
2	1200
3	2400
4	4800
5	9600
6	14400
*7	19200
8	38400
9	57600

### \* Default Setting

#### Implementation Class

The 7231 uses the Basic Implementation Class of the Modbus protocol. The table below shows configurations capabilities of the basic implementation class.

	Basic
Addressing	Configurable address from 1 to 247
Broadcast	Yes
Baud Rate	600 to 57,600 bps
Mode	RTU/ASC II
Parity	Even, None
Stop Bits	1 if Even Parity, 2 if No Parity,
Electrical Interface	RS-485 2W-Cabling
Connector Type	3 Wire Terminal

## 2.5 - Jumper Settings

In the Modbus slave configuration, jumpers JP2 and JP3 control the Modbus format (RTU or ASCII) and the communication settings, according to the chart below. The Data bits for the Down position of JP3 depend upon the setting of JP2 (RTU or ASCII format).

Note these jumpers have no effect when the 7231 HT is configured as a Modbus master.

JP2	JP3	Mode	Data bits	Stop bits	Parity
*Up	*Up	RTU	8	1	None
Up	Down	RTU	8	1	Even
Down	Up	ASCII	8	1	None
Down	Down	ASCII	7	1	Even

\* Default Setting

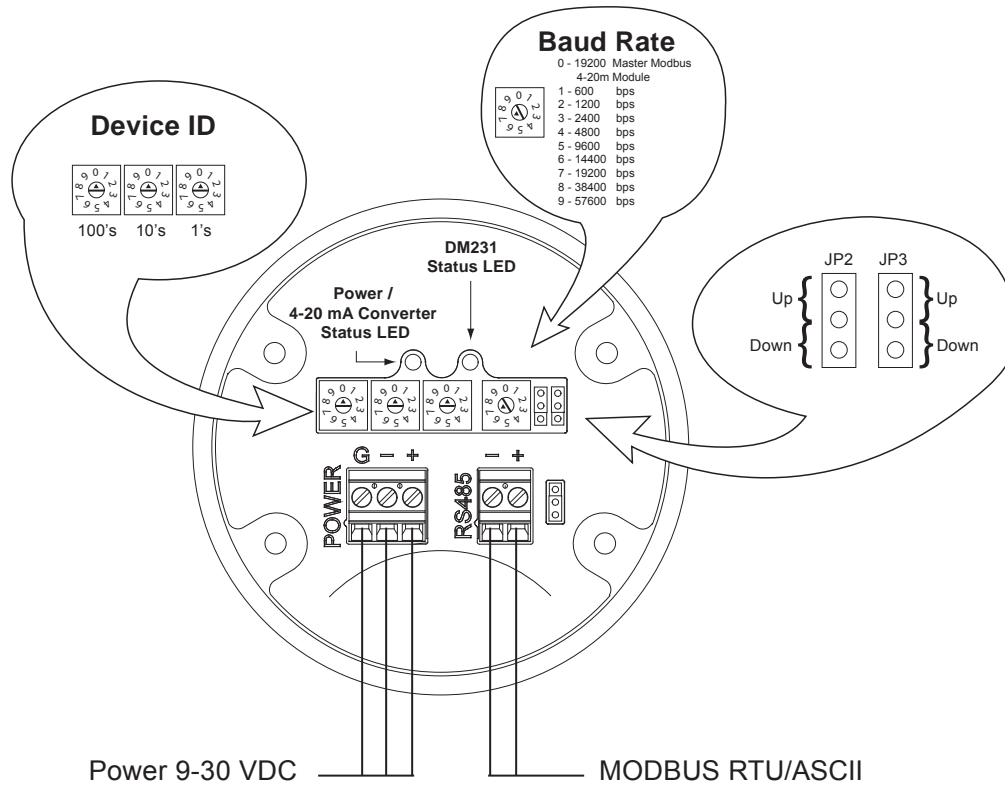

Figure 2.1 - 7231 Jumper & Switch Settings  
(Switches and jumpers shown in the default positions.)

## 2.6 - Data Points

The data points available are:

**Product** – Position of top float, in inches or centimeters.

**Interface** – Position of bottom float.

**Temperature** – Fahrenheit or Celsius.

**Average temperature** – Covered product and interface.

**Product temperature** – Average temperature of product only.

**Interface temperature** – Average temperature of interface only.

**Individual Temperature sensors** – 5 total, 1 is closest to the bottom of the probe, 5 is closest to the top.

**Maximum temperature** - Recorded by any of the sensors, saved through power cycles.

**Temperature sensor locations**- 5 total, indicates sensor location from bottom of tank.

## 2.7 - Error Codes

**Value of 2000** in the product or temperature registers indicates a loss of signal.

**Value of 2000** in the interface register indicates a loss of signal.

**Value of 1000** in the product register indicates a communication problem or “dead” probe.

**Value of 1000** in the interface register indicates a communication problem or “dead” probe.

**Status Bit Definitions** – Internal diagnostic indication (see Chart)

## 2.8 - Scaling

All integer formats are scaled X 100 so that the last 2 digits represent the decimal portion of the number. For example:

**Product reading:** 1790 = 17.90 inches

**Interface reading:** 563 = 5.63 inches

**Average Temperature:** 2382 = 23.82 degrees Celsius

## 2.9 - Holding and Input registers

All data points can be accessed as either a holding or an input register. Holding registers start with a 3XXXX and Input registers start with a 4XXXX. For example, product can be obtained at both registers 30203 and 40203.

## 2.10 - Enron Modbus

Enron Modbus has a few differences from Traditional Modbus. One difference is the register offsets follow a different numbering scheme, with integer values residing in the 3XXX range, long integers in the 5XXX range, and floating points in the 7XXX range. The second difference is that 32 bits of data can be returned in one register. The 7231 HT supports both of these features, by selection of the proper register value.

## 2.11 - Maximum registers

The maximum number of registers that can be accessed in a single Modbus request depends on the mode (RTU or ASCII) and the register size of the data (i.e Enron uses 4 data bytes per register for floats and longs)

- 1) For ASCII setting, accessing Enron floats or long integers, the maximum number of registers that can be requested is 30.
- 2) For all other modes, the maximum number is 36, which will retrieve all the data points in a single message.

## 2.12 - Examples of Accessing Data in the 7231 HT

**For the following examples, suppose we have these values:**

Product (level) reading: 200.74 inches, 509.88 cm

Interface reading: 120.39 inches, 305.79 cm

Average Temperature: 26.94 degrees C, 80.49 F

- 1) To access Product as an integer, Big Endian order, in inches: Request register 31803, length 1, value returned = 20074
- 2) To access Interface as a Floating Point, Little Endian order, in cm :Request register 30905, length 2, value returned = 305.79
- 3) To access Avg Temperature as a long integer, Big Endian Byte Swapped, in C: Request register 31511, length 2, value returned = 2694
- 4) To access product as an integer, Big Endian, in Enron addressing, in inches: Request register 3002, length 1, value returned = 20074
- 5) To access Interface as a Floating Point, Big Endian, in Enron addressing, in cm: Request register 7104, length 1, value returned = 305.79
- 6) To access Avg Temperature as a long integer, Little Endian in Enron addressing, in F: Request register 5610, length 1, value returned = 8049
- 7) To access all of the data points in Floating point, Big Endian, English units: Request register 30203, length 36

## 2.13 - Byte Ordering

In the Modbus slave configuration, data can be accessed as integers (16 bits), long integers (32 bits), and floating point value (32 bits). The order that the bytes are sent must be known by the master in order to assemble the bytes into the correct value. Byte ordering can have a few different terminologies.

- 1) Big/Little Endian.
- 2) Byte order by number, with 1 indicating the most significant part of the value, and 4 the least significant.
- 3) Word/Byte, indicating which word (16 bits, high or low) is sent first, and which byte of the word (high or low) come first in that byte.

See the following example for accessing a product reading of 46.60 inches. The integer value will be 4660, which translates to the hex number 0x00001234. The individual bytes, 0x00, 0x00, 0x12, and 0x34 can be sent the following 4 ways for 32 bits values:

- 1) Big Endian, Byte order 1234, High Word High Byte (HWHB) Order sent: 0x00, 0x00, 0x12, 0x34
- 2) Little Endian, Byte order 4321, Low Word Low Byte (LWLB) Order sent: 0x34, 0x12, 0x00, 0x00
- 3) Big Endian Byte Swapped, Byte order 2143, High Word Low Byte (HWLB) Order sent: 0x00, 0x00, 0x34, 0x12
- 4) Little Endian Byte Swapped, Byte order 3412, Low Word High Byte (LWHB) Order sent: 0x12, 0x34, 0x00, 0x00

The individual bytes 0x12, and 0x34 can be sent the following 2 ways for 16 bits values:

- 1) Big Endian, Byte order 12, High Byte first (HB) Order sent: 0x12, 0x34
- 2) Little Endian, Byte order 21, Low Byte first (LB) Order sent: 0x34, 0x12

## 2.14 - Modbus Map

Use the following tables to find the register number for the desired format. First, go to the section for the number format you desire (integer, long integer, or floating point). Then find the table with the desired units, English or metric. Then find the value (product, interface, average temperature, etc) in the left hand column. Next, find the desired byte ordering across the top row. The corresponding entry at the intersection of these 2 items gives the register that should be specified in the Modbus master request message. The number of registers needed to obtain the value is also specified for each format.

### NOTE:

HWHB = High Word High byte  
LWHB = Low Word High Byte,  
HWLB = High word low byte  
LWLB = Low Word low byte

## 2.15 Modbus Registers

**Integer (16 bit Signed) formats**  
**Signed 16 bit Integer, 16 bits of data per register,**  
**1 register needed to get value English Units,**  
**inches and degrees F**

Data	Big Endian/ Hi Byte first	Little Endian/ Low Byte first
Product	31803	32003
Interface	31805	32005
product temperature	31807	32007
interface temperature	31809	32009
average temperature	31811	32011
status	31813	32013
Span	31815	32015
temperature 1	31817	32017
temperature 2	31819	32019
temperature 3	31821	32021
temperature 4	31823	32023
temperature 5	31825	32025
max temperature	31827	32027
temperature sensor 1 location (closest to bottom)	31829	32029
temperature sensor 2 location	31831	32031
temperature sensor 3	31833	32033
temperature sensor 4 location	31835	32035
temperature sensor 5 location (closest to top)	31837	32037
Software version	31899	32099

**Signed 16 bit Integer, 16 bits of data per register, 1**  
**register needed to get value Metric Units,**  
**centimeters and degrees C**

Data	Big Endian/ Hi Byte first	Little Endian/ Low Byte first
Product	31903	32103
Interface	31905	32105
product temperature	31907	32107
interface temperature	31909	32109
average temperature	31911	32111
status	31913	32113
Span	31915	32115
temperature 1	31917	32117
temperature 2	31919	32119
temperature 3	31921	32121
temperature 4	31923	32123
temperature 5	31925	32125
max temperature	31927	32127
temperature sensor 1 location (closest to bottom)	31929	32129
temperature sensor 2 location	31931	32131
temperature sensor 3	31933	32133
temperature sensor 4 location	31935	32135
temperature sensor 5 location (closest to top)	31937	32137
Software version	31999	32199

**Enron Modbus, Signed 16 bit Integer, 16 bits of data per register, 1 register needed to get value**

Data	Big Endian/ Hi Byte first	Little Endian/ Low Byte first
Product	3002	3202
Interface	3004	3204
product temperature	3006	3206
interface temperature	3008	3208
average temperature	3010	3210
status	3012	3212
Span	3014	3214
temperature 1	3016	3216
temperature 2	3018	3218
temperature 3	3020	3220
temperature 4	3022	3222
temperature 5	3024	3224
max temperature	3026	3226
temperature sensor 1 location (closest to bottom)	3028	3228
temperature sensor 2 location	3030	3230
temperature sensor 3	3032	3232
temperature sensor 4 location	3034	3234
temperature sensor 5 location (closest to top)	3036	3236
Software version	3098	3298

**Enron Modbus, Signed 16 bit Integer, 16 bits of data per register, 1 register needed to get value**

Data	Big Endian/ Hi Byte first	Little Endian/ Low Byte first
Product	3102	3302
Interface	3104	3304
product temperature	3106	3306
interface temperature	3108	3308
average temperature	3110	3310
status	3112	3312
Span	3114	3314
temperature 1	3116	3316
temperature 2	3118	3318
temperature 3	3120	3320
temperature 4	3122	3322
temperature 5	3124	3324
max temperature	3126	3326
temperature sensor 1 location (closest to bottom)	3128	3328
temperature sensor 2 location	3130	3330
temperature sensor 3	3132	3332
temperature sensor 4 location	3134	3334
temperature sensor 5 location (closest to top)	3136	3336
Software version	3198	3398

2.16 - Floating Point Formats

**Floating Point, 32 bit, 16 bits of data per register, 2 registers needed to get value English Units, inches and degrees F**

Data	Big Endian/ HWHB/ 1234	Little Endian/ Byte Swapped/ LWHB/3412	Big Endian/ Byte Swapped/ HWLB/2143	Little Endian/ LWHB/4321
Product	30203	30403	30603	30803
Interface	30205	30405	30605	30805
product temperature	30207	30407	30607	30807
interface temperature	30209	30409	30609	30809
average temperature	30211	30411	30611	30811
status	30213	30413	30613	30813
Span	30215	30415	30615	30815
temperature 1	30217	30417	30617	30817
temperature 2	30219	30419	30619	30819
temperature 3	30221	30421	30621	30821
temperature 4	30223	30423	30623	30823
temperature 5	30225	30425	30625	30825
max temperature	30227	30427	30627	30827
temperature sensor 1 location (closest to bottom)	30229	30429	30629	30829
temperature sensor 2 location	30231	30431	30631	30831
temperature sensor 3	30233	30433	30633	30833
temperature sensor 4 location	30235	30435	30635	30835
temperature sensor 5 location (closest to top)	30237	30437	30637	30837
Software version	30299	30499	30699	30899

**Floating Point, 32 bit, 16 bits of data per register, 2 registers  
needed to get value Metric Units, centimeters and degrees C**

Data	Big Endian/ HWHB/ 1234	Little Endian/ Byte Swapped/ LWHB/3412	Big Endian/ Byte Swapped/ HWLB/2143	Little Endian/ LWHB/4321
Product	30303	30503	30703	30903
Interface	30305	30505	30705	30905
product temperature	30307	30507	30707	30907
interface temperature	30309	30509	30709	30909
average temperature	30311	30511	30711	30911
status	30313	30513	30713	30913
Span	30315	30515	30715	30915
temperature 1	30317	30517	30717	30917
temperature 2	30319	30519	30719	30919
temperature 3	30321	30521	30721	30921
temperature 4	30323	30523	30723	30923
temperature 5	30325	30525	30725	30925
max temperature	30327	30527	30727	30927
temperature sensor 1 location (closest to bottom)	30329	30529	30729	30929
temperature sensor 2 location	30331	30531	30731	30931
temperature sensor 3	30333	30533	30733	30933
temperature sensor 4 location	30335	30535	30735	30935
temperature sensor 5 location (closest to top)	30337	30537	30737	30937
Software version	30399	30599	30799	30999

**Enron Modbus, Floating Point, 32 bit, 32 bits of data per register, 1  
register needed to get value English Units, inches and degrees F**

Data	Big Endian/ HWHB/ 1234	Little Endian/ Byte Swapped/ LWHB/3412	Big Endian/ Byte Swapped/ HWLB/2143	Little Endian/ LWHB/4321
Product	7002	7202	7402	7602
Interface	7004	7204	7404	7604
product temperature	7006	7206	7406	7606
interface temperature	7008	7208	7408	7608
average temperature	7010	7210	7410	7610
status	7012	7212	7412	7612
Span	7014	7214	7414	7614
temperature 1	7016	7216	7416	7616
temperature 2	7018	7218	7418	7618
temperature 3	7020	7220	7420	7620
temperature 4	7022	7222	7422	7622
temperature 5	7024	7224	7424	7624
max temperature	7026	7226	7426	7626
temperature sensor 1 location (closest to bottom)	7028	7228	7428	7628
temperature sensor 2 location	7030	7230	7430	7630
temperature sensor 3	7032	7232	7432	7632
temperature sensor 4 location	7034	7234	7434	7634
temperature sensor 5 location (closest to top)	7036	7236	7436	7636
Software version	7098	7298	7498	7698

**Enron Modbus, Floating Point, 32 bit, 32 bits of data per register, 1 register needed to get value Metric Units, centimeters and degrees C**

Data	Big Endian/ HWHB/ 1234	Little Endian/ Byte Swapped/ LWHB/3412	Big Endian/ Byte Swapped/ HWLB/2143	Little Endian/ LWHB/4321
Product	7002	7202	7402	7602
Interface	7004	7204	7404	7604
product temperature	7006	7206	7406	7606
interface temperature	7008	7208	7408	7608
average temperature	7010	7210	7410	7610
status	7012	7212	7412	7612
Span	7014	7214	7414	7614
temperature 1	7016	7216	7416	7616
temperature 2	7018	7218	7418	7618
temperature 3	7020	7220	7420	7620
temperature 4	7022	7222	7422	7622
temperature 5	7024	7224	7424	7624
max temperature	7026	7226	7426	7626
temperature sensor 1 location (closest to bottom)	7028	7228	7428	7628
temperature sensor 2 location	7030	7230	7430	7630
temperature sensor 3	7032	7232	7432	7632
temperature sensor 4 location	7034	7234	7434	7634
temperature sensor 5 location (closest to top)	7036	7236	7436	7636
Software version	7098	7298	7498	7698

**Enron Modbus, Floating Point, 32 bit, 32 bits of data per register, 1 register needed to get value Metric Units, centimeters and degrees C**

Data	Big Endian/ HWHB/ 1234	Little Endian/ Byte Swapped/ LWHB/3412	Big Endian/ Byte Swapped/ HWLB/2143	Little Endian/ LWHB/4321
Product	7102	7302	7502	7702
Interface	7104	7304	7504	7704
product temperature	7106	7306	7506	7706
interface temperature	7108	7308	7508	7708
average temperature	7110	7310	7510	7710
status	7112	7312	7512	7712
Span	7114	7314	7514	7714
temperature 1	7116	7316	7516	7716
temperature 2	7118	7318	7518	7718
temperature 3	7120	7320	7520	7720
temperature 4	7122	7322	7522	7722
temperature 5	7124	7324	7524	7724
max temperature	7126	7326	7526	7726
temperature sensor 1 location (closest to bottom)	7128	7328	7528	7728
temperature sensor 2 location	7130	7330	7530	7730
temperature sensor 3	7132	7332	7532	7732
temperature sensor 4 location	7134	7334	7534	7734
temperature sensor 5 location (closest to top)	7136	7336	7536	7736
Software version	7198	7398	7598	7798



**Long, 32 bit, 16 bits of data per register, 2 registers needed to get value  
English Units, inches and degrees F**

Data	Big Endian/ HWHB/ 1234	Little Endian/ Byte Swapped/ LWLB/3412	Big Endian/ Byte Swapped/ HWLB/2143	Little Endian/ LWLB/4321
Product	31003	31203	31403	31603
Interface	31005	31205	31405	31605
product temperature	31007	31207	31407	31607
interface temperature	31009	31209	31409	31609
average temperature	31011	31211	31411	31611
status	31013	31213	31413	31613
Span	31015	31215	31415	31615
temperature 1	31017	31217	31417	31617
temperature 2	31019	31219	31419	31619
temperature 3	31021	31221	31421	31621
temperature 4	31023	31223	31423	31623
temperature 5	31025	31225	31425	31625
max temperature	31027	31227	31427	31627
temperature sensor 1 location (closest to bottom)	31029	31229	31429	31629
temperature sensor 2 location	31031	31231	31431	31631
temperature sensor 3	31033	31233	31433	31633
temperature sensor 4 location	31035	31235	31435	31635
temperature sensor 5 location (closest to top)	31037	31237	31437	31637
Software version	31099	31299	31499	31699

**Long, 32 bit, 16 bits of data per register, 2 registers needed to get value  
Metric Units, centimeters and degrees C**

Data	Big Endian/ HWHB/ 1234	Little Endian/ Byte Swapped/ LWLB/3412	Big Endian/ Byte Swapped/ HWLB/2143	Little Endian/ LWLB/4321
Product	31103	31303	31503	31703
Interface	31105	31305	31505	31705
product temperature	31107	31307	31507	31707
interface temperature	31109	31309	31509	31709
average temperature	31111	31311	31511	31711
status	31113	31313	31513	31713
Span	31115	31315	31515	31715
temperature 1	31117	31317	31517	31717
temperature 2	31119	31319	31519	31719
temperature 3	31121	31321	31521	31721
temperature 4	31123	31323	31523	31723
temperature 5	31125	31325	31525	31725
max temperature	31127	31327	31527	31727
temperature sensor 1 location (closest to bottom)	31129	31329	31529	31729
temperature sensor 2 location	31131	31331	31531	31731
temperature sensor 3	31133	31333	31533	31733
temperature sensor 4 location	31135	31335	31535	31735
temperature sensor 5 location (closest to top)	31137	31337	31537	31737
Software version	31199	31399	31599	31799

**Enron Modbus, Long, 32 bit, 32 bits of data per register, 1 register needed to get value  
English Units, inches and degrees F**

Data	Big Endian/ HWHB/ 1234	Little Endian/ Byte Swapped/ LWLB/3412	Big Endian/ Byte Swapped/ HWLB/2143	Little Endian/ LWLB/4321
Product	5002	5202	5402	5602
Interface	5004	5204	5404	5604
product temperature	5006	5206	5406	5606
interface temperature	5008	5208	5408	5608
average temperature	5010	5210	5410	5610
status	5012	5212	5412	5612
Span	5014	5214	5414	5614
temperature 1	5016	5216	5416	5616
temperature 2	5018	5218	5418	5618
temperature 3	5020	5220	5420	5620
temperature 4	5022	5222	5422	5622
temperature 5	5024	5224	5424	5624
max temperature	5026	5226	5426	5626
temperature sensor 1 location (closest to bottom)	5028	5228	5428	5628
temperature sensor 2 location	5030	5230	5430	5630
temperature sensor 3	5032	5232	5432	5632
temperature sensor 4 location	5034	5234	5434	5634
temperature sensor 5 location (closest to top)	5036	5236	5436	5636
Software version	5098	5298	5498	5698

**Enron Modbus, Long, 32 bit, 32 bits of data per register, 1 register needed to get value  
Metric Units, centimeters and degrees C**

Data	Big Endian/ HWHB/ 1234	Little Endian/ Byte Swapped/ LWLB/3412	Big Endian/ Byte Swapped/ HWLB/2143	Little Endian/ LWLB/4321
Product	5102	5302	5502	5702
Interface	5104	5304	5504	5704
product temperature	5106	5306	5506	5706
interface temperature	5108	5308	5508	5708
average temperature	5110	5310	5510	5710
status	5112	5312	5512	5712
Span	5114	5314	5514	5714
temperature 1	5116	5316	5516	5716
temperature 2	5118	5318	5518	5718
temperature 3	5120	5320	5520	5720
temperature 4	5122	5322	5522	5722
temperature 5	5124	5324	5524	5724
max temperature	5126	5326	5526	5726
temperature sensor 1 location (closest to bottom)	5128	5328	5528	5728
temperature sensor 2 location	5130	5330	5530	5730
temperature sensor 3	5132	5332	5532	5732
temperature sensor 4 location	5134	5334	5534	5734
temperature sensor 5 location (closest to top)	5136	5336	5536	5736
Software version	5198	5398	5598	5798

## 2.17 - Status Bit Definitions

Bit	Definition
0-7	Reserved
8	Magnet missing/ Fault with Product or Interface
9	Temperature 1 Fault
10	Temperature 2 Fault
11	Temperature 3 Fault
12	Temperature 4 Fault
13	Temperature 5 Fault
14	Span (Probe Length)
15	Not connected to probe
16-31	Reserved

**Common values:**

Status = 256 indicates magnet error  
 Status = 32768 indicates 7231 HT  
 not communicating with probe

## Section 3 - 7235 ASCII Digital Set Up and Wiring

The wiring for the 7235 HT Digital probe is illustrated in Figure 5 and connects to a standard terminal block located in the housing as shown in Drawing E0242100, Sheet 2. The 7235 is also approved for hazardous locations, so it is important to use the appropriate conduit and seals. The recommend cable is a three conductor with shield, Belden# 6501FE, 22 AWG and the maximum recommended cable length is 150 feet.



**CAUTION**

Since the probe has an explosion proof approval for hazardous locations, it is important to use the appropriated conduit and seals. All installations should comply with the latest edition of The National Electrical Code (ANSI/NFPA 70) and the Canadian Electrical Code (CEC).



**CAUTION**

Do not remove the explosion proof cover in a hazardous area. You must make certain that the power is locked out and the area is safe. When servicing is completed, the cover must be replaced and secured with the set screw before power is applied to the instrument.

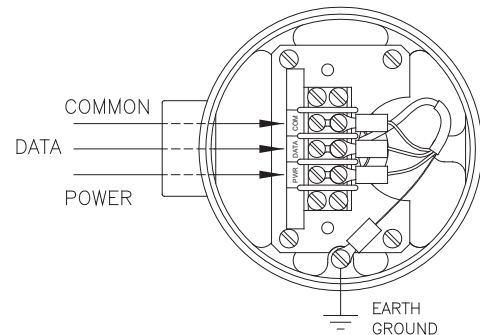

Figure 3.1 - 7235 Wiring

### 3.1 - 7235 Digital Configuration

#### Data Signal

The "Data" signal is an "open-drain" type signal and is used for the bidirectional half duplex asynchronous serial communications. Any device connected to the probe must be of an "open-drain" type signal and must

not be driven to a high logic level. Because this data signal may be driven by either the master or any slave device, a single pull up resistor of typically 1kΩ should be the only element that establishes the high logic level voltage. Also, because of this scheme, there could be multiple master or slave devices connected together.

The logic level voltage thresholds are similar to TTL levels and a pull-up resistor must be included in the user's interface circuitry. This signal is clamped internally by the 7235 with a +5V TVS device. The inactive or "idle" state is at a "high" logic level.

#### Power Consumption

The 7235 draws roughly 13mA of current when it is not taking temperature measurements and roughly 15mA of current when it is taking temperature measurements (with 5 temperature sensors).

#### Communication Parameters (fixed)

baud 9600  
 parity odd  
 data bits 7  
 start bits 1  
 stop bits 1

### 3.2 - 7235 Data Format

The data string is in ASCII format and the total data string transmission time is roughly one (1) second.

Approximately 100ms after power up, a carat ('^') character is transmitted and the first product position is measured and transmitted. Subsequent position measurement and transmission continues every 100ms until 10 products have been transmitted. One interface position is transmitted immediately following the 10th product position. All temperature data is then transmitted along with a final 2-digit ASCII Checksum followed by a Carriage Return character to end the string. This whole data string transmission process continuously repeats itself while power is applied to the probe.

**NOTE:** A comma character is transmitted between each position and temperature measurement (see example in Data String table).

The data string length is 139 bytes total. The data string is comprised of a carat ('^') character (i.e. start character), 10 product levels, 1 interface level, and 5 temperature sensor levels followed by a 2-digit ASCII Check sum and a carriage return character (<CR>).

Data String	
^,ppp.pppp,ppp.pppp,... ...,ppp.pppp,iii.iiii,+/-ttt.t,...,+/-ttt.t,CC<cr>	
^:	Start Character (identifies protocol, type and quantity of following data)
ppp.pppp:	Product (000.0000" to 600.0000")
iii.iiii:	Interface (000.0000" to 600.0000") (NOTE: Interface = 000.0000 if Stik is ordered with only 1 float)
+/-ttt.t:	Temperature (-40.0°C to +125.0°C)
CC:	2 digit ASCII checksum (see calculation of checksum below)
<cr>:	End of data string - carriage return

For probes ordered with only 1 temperature sensor (i.e. T1 or R1), a temperature reading is taken on that one temperature sensor and that value is placed in all five temperature data locations in the string.

**NOTE:** Data values outside the ranges specified above indicate an error condition.

A value of "999.9999" will be transmitted if there is an error in the product or interface levels. A value of "-999.9" will be transmitted if there is an error in the temperature sensor measurement.

#### Calculation of Checksum

All characters (from and including the start character (^) to and including the comma (,) after the final temperature digit) in the data string are added up to a byte (8-bit) value. Take the upper nibble (4-bits) and lower nibble (4-bits) of that byte and convert each nibble value to its equivalent ASCII character.

#### For example:

If all the characters add up to 0xA5 (hex); it would transmit an 'A' and a '5' char to represent the upper and lower nibble values. The 2-digit ASCII checksum (CC) would be: 0x41 0x35 (or the ASCII equivalent chars 'A' '5').

#### Data Transmission Example

The following example represents the data transmitted from a 7235 HR Digital Stik.

The following example represents a full transmission data string (139 bytes) from a 7235 HR Digital Stik probe with the following information (Bytes 0 - 135 are used to compute the checksum):

**NOTE:** The Level data in the following chart may not be representative of a valid product level. The data is for demonstration purposes only.

Data Transmission		
Byte #s	ASCII Chr String	Level Name
0-1	^,	Start Character
2-10	123.4567,	Product 1
11-19	456.7890,	Product 2
20-28	654.3212,	Product 3
29-37	987.6543,	Product 4
38-46	124.5789,	Product 5
47-55	234.5678,	Product 6
56-64	267.4310,	Product 7
65-73	478.2354,	Product 8
74-82	752.6143,	Product 9
83-91	891.4578,	Product 10
92-100	002.5389,	Interface 1
101-107	+122.1,	Temperature 1
108-114	+122.3,	Temperature 2
115-121	+122.5,	Temperature 3
122-128	+122.3,	Temperature 4
129-135	+122.1,	Temperature 5
136-137	CC	2-digit ASCII Checksum
138	<cr>	Carriage Return

## Section 4 - Basic Trouble Shooting: 7230 HT Series Magnetostrictive Probes

### Symptoms:

No Signal  
 Intermittent Signal  
 Erratic Temperature reading  
 Faulty water level measurement  
 Faulty product level measurement

### Diagnostics:

#### 1. Check error codes for 7231 HT Modbus probe

- Error Codes (page 10)
  - a) Value of 2000 in the product, interface or temperature registers indicates a loss of signal.
  - b) Value of 1000 in the product or interface register indicates a communication problem or a "dead" probe.

#### 2. Check error codes for 7235 HT Digital probe

- Error Codes (page 18)
  - a) 999.9999 error of signal for product or interface level.
  - b) -99.9 error of signal from temperature sensor. (see page 18)

#### 3. Locating the Problem Source

- Is the problem with the probe or elsewhere? Connect a working (or demo) probe from another tank to confirm that the problem is related to the probe and not the wiring or communications.
- Does the wiring (ground and signal) and power meet the specifications? If not, you can have erratic or complete loss of signal.
- Has the PLC/controller been setup properly to work with this probe?

#### 4. Floats

- Are the correct number of floats being used?, F1 is one float, F2 is two floats.
- Are the floats correctly installed? The product float must be positioned above the Interface (water) float.
- Were the floats supplied (or evaluated) by APT? Internal magnet must match probe.
- Are the floats "sticking" or moving freely? No build-up on probe.
- Are the magnets in the product and interface floats 4 inches apart on a long probe?

#### 5. Magnetic Fields

- Was the head of the probe accidentally magnetized? This can be done in the field and can cause significant problems. Degauss the head of the probe.
- Is there a magnet field in the tank? Pull the probe partially out of the tank about 2 ft to see if the problem is resolved.

#### 6. Unexpected Readings

- Confirm actual levels and temperature reading directly from Probe. Compare these to known values. This can be done manually in the field. Make sure that temperature sensors located outside of the liquid are not being used to calculate an average.

REVISION		DESCRIPTION	DATE	BY
REV. A		REVISED NULL ZONE & DEAD BAND DIM	12/21/06	KTP
REV. B		REVISED MIN LENGTHS & TEMP SENSOR SPACING	08/19/08	KTP

HIGH TEMPERATURE APPLICATIONS UP TO 125°C

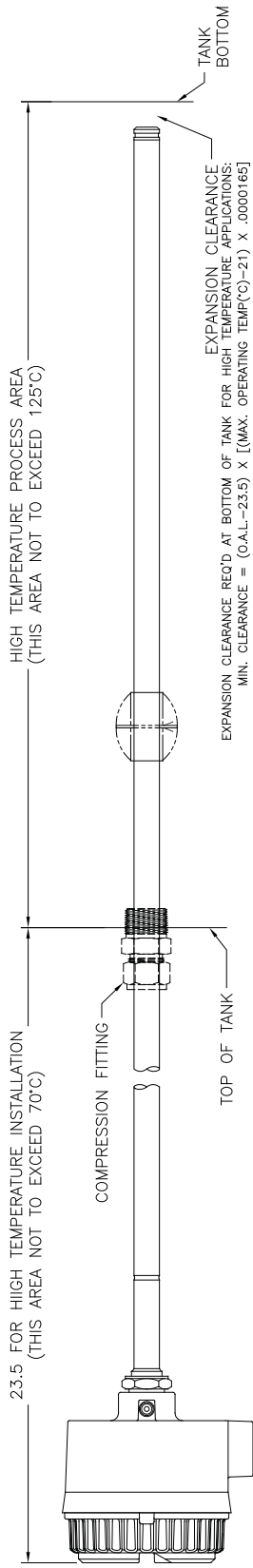

APPLICATIONS UP TO 70°C

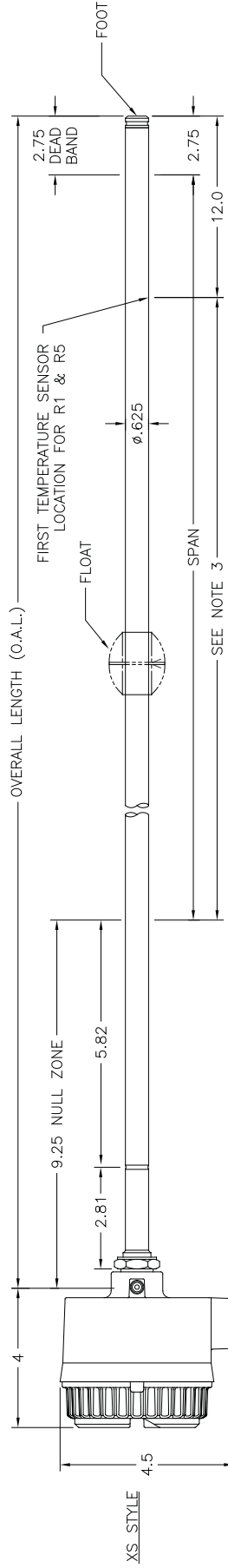

STANDARD PROBE LENGTHS:

TEMPERATURE SENSOR TYPE	MAXIMUM O.A.L. (in)	MINIMUM SPAN (in)	MINIMUM O.A.L. (in) -40°C TO 70°C	FIRST TEMPERATURE SENSOR SPACING @ 125°C	REMAINDER TEMPERATURE SENSOR SPACING @ 21°C
R5	288	24	41	47	(TEMP. SPAN-9.25)/5
R1	288	10	29	33	-
T1	288	2	21	25	-

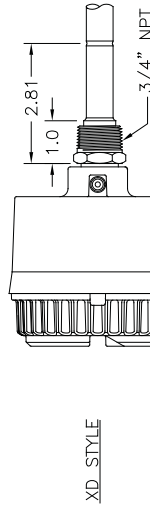

NOTES: UNLESS OTHERWISE SPECIFIED

1. ALL DIMENSIONS ARE FOR REFERENCE ONLY.
2. ENSURE MAGNET DOES NOT ENTER NULL ZONE AND DEAD BAND AREAS.
3. TEMPERATURE SENSORS ARE SPACED EQUALLY OVER RANGE SPECIFIED.
4. FOR FIVE TEMPERATURE SENSOR PROBES, SENSORS ARE NUMBERED R1 TO R5 WITH R1 BEING NEAREST TO FOOT OF PROBE AND R5 NEAREST TO ENCLOSURE.

THIRD ANGLE PROJECTION		DR. KTP	TITLE
		DATE 09/15/06	DIMENSION DRAWING
SURFACE FINISH $\sqrt{63}$ UNLESS OTHERWISE SPECIFIED TOLERANCE ALLOWANCE UNLESS OTHERWISE SPECIFIED: +/- 0.010 ON 2 PLACE DECIMALS +/- 0.0005 ON 4 PLACE DECIMALS +/- .30 MIN. ON ALL ANGLES		APP.	7230 SERIES HT
		SCALE	DIGITAL STIK
		NONE	DRAWING NO. D0257800
			REV. SIZE B B



REV.	DESCRIPTION	REVISION	DATE	BY
A	ADDED RS-485 TO 7231 OUTPUT		8/11/08	KTP

**\*\*APPROVED DOCUMENT\*\***  
CHANGES TO THIS DOCUMENT  
REQUIRE AGENCY APPROVAL

HAZARDOUS AREA  
XP CL I, DIV I, GRP A,B,C,D

NON HAZARDOUS AREA

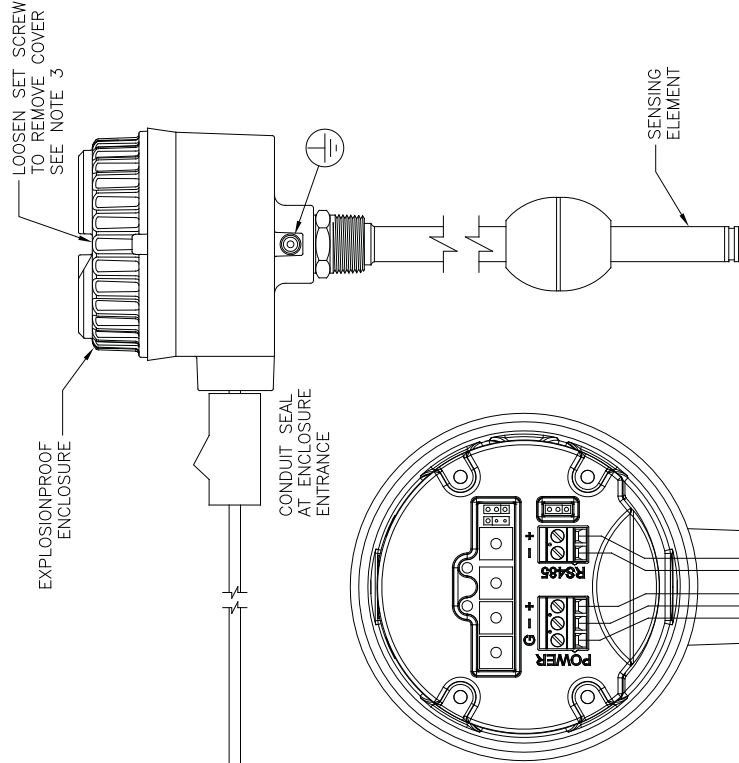

7231 SERIES  
SHEET 1 OF 2

MODBUS RS-485  
POWER 10-30V

THIRD ANGLE PROJECTION	DR.	TITLE	REV. I	REV. SIZE
	KTP	DRAWING INSTALLATION 723X SERIES (2 SHEETS)	A	B
SURFACE FINISH UNLESS OTHERWISE SPECIFIED	DATE 10/17/06	DRAWING NO.	E0242100	
TOLERANCE ALLOWANCE UNLESS OTHERWISE SPECIFIED:	APP.	SCALE	FULL	
+/- 0.010 ON 3 PLACE DECIMALS				
+/- 0.0005 ON 4 PLACE DECIMALS				
+/- .30 MIN. ON ALL ANGLES				

AMETEK  
AUTOMATION & PROCESS TECHNOLOGIES  
Clawson, MI 48017 U.S.A.

- NOTES: UNLESS OTHERWISE SPECIFIED
- INSTALLATIONS SHALL COMPLY WITH THE LATEST EDITION OF THE NATIONAL ELECTRICAL CODE (ANSI/NFPA 70) AND THE CANADIAN ELECTRICAL CODE (CEC).
  - UNUSED OPENINGS MUST BE PROPERLY SEALED TO MAINTAIN ENCLOSURE ENVIRONMENTAL AND/OR HAZARDOUS LOCATION RATINGS.
  - BEFORE REMOVING THE EXPLOSION PROOF HOUSING COVER IN A POTENTIALLY HAZARDOUS AREA, MAKE CERTAIN THAT THE AREA IS SAFE. WHEN SERVICING IS COMPLETE, THE COVER MUST BE REPLACED. SECURE SET SCREW AFTER REPLACING COVER.
  - CONDUIT SEAL AT ENCLOSURE ENTRANCE.

NON HAZARDOUS AREA		HAZARDOUS AREA	
XP CL I, DIV I, GRP A,B,C,D		XP CL I, DIV I, GRP A,B,C,D	
REV.	DESCRIPTION	DATE	BY
A	ADDED RS-485 TO 7231 OUTPUT	8/11/08	KTP

**\*\*APPROVED DOCUMENT\*\***  
 CHANGES TO THIS DOCUMENT  
 REQUIRE AGENCY APPROVAL

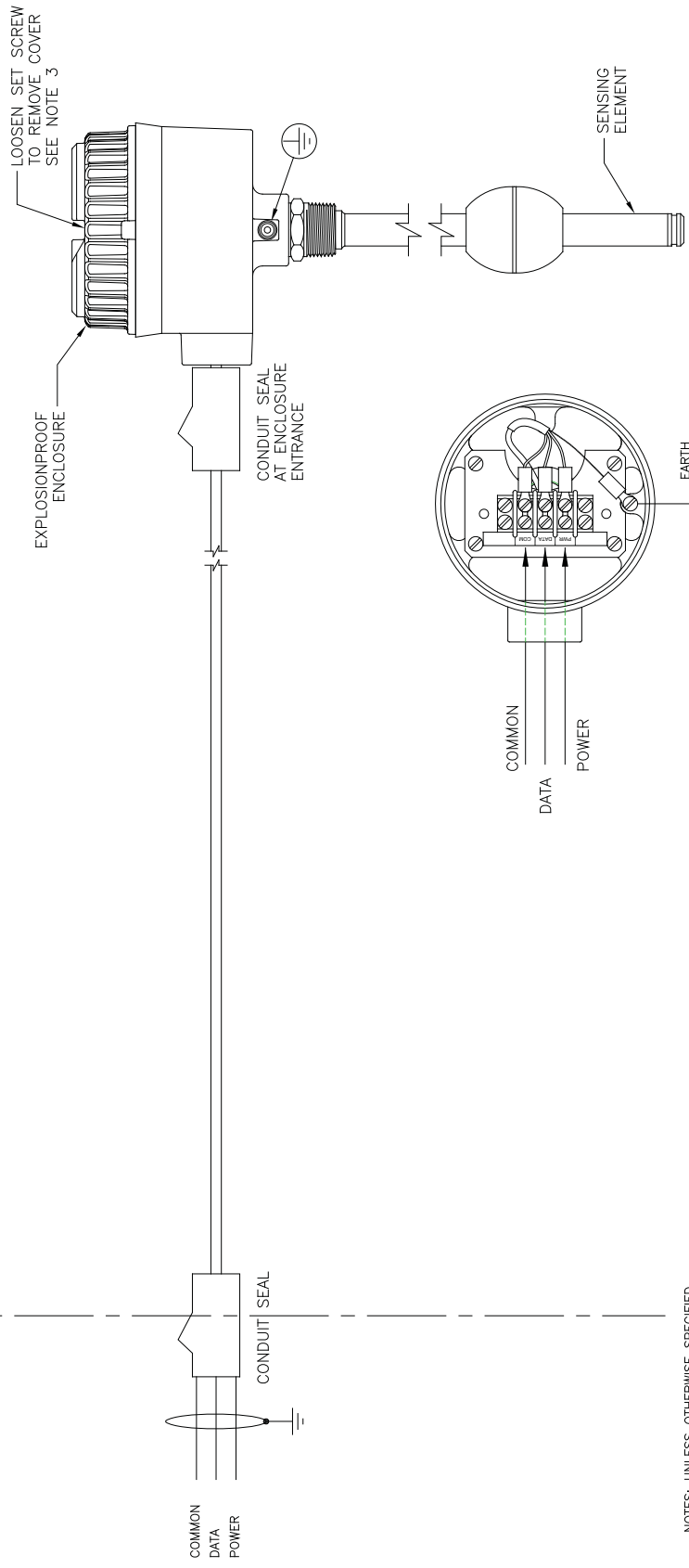

7235 SERIES  
 SHEET 2 OF 2

- NOTES: UNLESS OTHERWISE SPECIFIED
1. INSTALLATIONS SHALL COMPLY WITH THE LATEST EDITION OF THE NATIONAL ELECTRICAL CODE (ANSI/NFPA 70) AND THE CANADIAN ELECTRICAL CODE (CEC).
  2. UNUSED OPENINGS MUST BE PROPERLY SEALED TO MAINTAIN ENCLOSURE ENVIRONMENTAL AND/OR HAZARDOUS LOCATION RATINGS.
  3. BEFORE REMOVING THE EXPLOSION PROOF HOUSING COVER IN A POTENTIALLY HAZARDOUS AREA, MAKE CERTAIN THAT THE AREA IS SAFE. WHEN SERVICING IS COMPLETE, THE COVER MUST BE REPLACED. SECURE SET SCREW AFTER REPLACING COVER.
  4. CONDUIT SEAL AT ENCLOSURE ENTRANCE.

THIRD ANGLE PROJECTION	DR. KTP	TITLE
SURFACE FINISH 63/	DATE 10/17/06	DRAWING INSTANTATION
UNLESS OTHERWISE SPECIFIED	APP.	723X SERIES (2 SHEETS)
TOLERANCE ALLOWANCE	DATE	DRAWING NO.
UNLESS OTHERWISE SPECIFIED:	SCALE	E0242100
+/- 0.010 ON 2 PLACE DECIMALS	FULL	REV. SIZE
+/- 0.005 ON 3 PLACE DECIMALS		A B
+/- 0.0005 ON 4 PLACE DECIMALS		
+/- .05 MIN. ON ALL ANGLES		

AMETEK AUTOMATION & PROCESS TECHNOLOGIES  
 AUTOMATION & PROCESS TECHNOLOGIES  
 Clawson, MI 48017 U.S.A.

# Notes

---

Part Number

---

Serial Number

---

Purchase Order Number

---

Sales Order Number

---

---

Comments

---

---

---

---

---

---

---

---

---

---

---

---

## Section 5 - Equipment Return

Contact your Distributor before returning equipment to the factory. In order to provide prompt and reliable service, any equipment being returned for repair or credit, must be pre-approved by the factory. For all UPS shipments, notify your driver and the UPS office immediately. You must file a claim with UPS as soon as possible. Then advise H&R Mfg. and Supply for reshipment, etc. Keep damaged goods and shipping containers for UPS inspection. UPS must inspect damage if claim is to be processed.

For all Common Carrier shipments, damage must be reported on the delivery receipt and the claim filed at the destination. Be sure to check your order very carefully upon arrival.

**You must have a Returned Material Authorization Number! To obtain a Returned Material Authorization (RMA#), contact your distributor.**

**Please provide the following information:**

- Model Number of returned equipment
- Serial Number
- Original Purchase Order Number
- Detailed description of the failure
- Contact Name and Phone Number

In many applications, the probes are exposed to hazardous materials. It is your responsibility to fully disclose all chemicals and decontaminate the entire product.

- OSHA mandates that our employees be informed and protected from hazardous chemicals.
- A **Material Safety Data Sheet (MSDS)** listing any hazardous material to which the probe has been exposed **MUST** accompany any return.

## Section 6 - Warranty

All AMETEK APT electronic level instruments are warranted to be free of defects in materials or workmanship for one full year from the date of original factory shipment.

If returned within the warranty period, and upon factory inspection to determine whether the cause of the claim is covered under the warranty, AMETEK APT will repair or replace the instrument at no cost to the purchaser (or owner), other than transportation.

AMETEK APT shall not be liable for misapplication, labor claims, director or consequential damage or expense arising from the installation or use of the equipment. There are no other warranties expressed or implied. A complete description of the product warranty is contained in the Terms and Conditions of Sale.





Other Products



- GEMCO**
- LINEAR DISPLACEMENT TRANSDUCERS
- PLC INTERFACE PRODUCTS
- ROTARY POSITION PRODUCTS
- PROGRAMMABLE LIMIT SWITCHES
- EXTREME DUTY CABLE REEL PRODUCTS
- ROTARY LIMIT SWITCHES
- RESOLVERS
- MILL DUTY ENCLOSURES
- ULTRA HIGH SPEED PLS
- SAFETY PRODUCTS

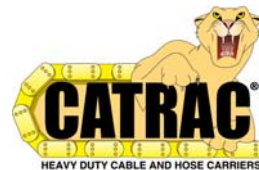

Copyright 2008 by AMETEK AUTOMATION & PROCESS TECHNOLOGIES.  
All Rights Reserved.



1080 N. Crooks Road, Clawson, MI 48017-1097  
Phone: 248-435-0700 Toll Free: 800-635-0289  
Fax: 248-435-8120 [www.ametekapt.com](http://www.ametekapt.com)

7230.M3R  
3/09.Z277

\*\*APPROVED DOCUMENT\*\*  
CHANGES TO THIS DOCUMENT  
REQUIRE AGENCY APPROVAL

