

SOLID STATE ALARM PANELS

VERSATILE NEW ALARM DETECTS MOISTURE, LEAKS AND HIGH LEVELS, PLUS OFF-NORMAL CONDITIONS INVOLVING A WIDE VARIETY OF PROCESS VARIABLES AND BUILDING SECURITY APPLICATIONS

BIW Series 8041 Solid-State Alarm Systems are designed to provide new versatility, safety and reliability in monitoring and detecting off-normal conditions in a broad range of industrial, commercial and institutional applications.

Key feature of the system is its low energy adjustable sensing circuit which assures reliable operation from electrodes contacting conductive liquids or from contact-type pilot devices such as flow, float, pressure and limit switches, thermostats and pushbutton actuators, etc.

As a result, the system can be used to detect moisture or leaks in mines, underground communication networks, boat bilges, computer rooms, libraries, archives and record storage areas. It is also ideal for monitoring dangerous high level conditions in storage tanks, cooling towers, storm drain sumps, septic tanks, sewer systems, lakes, streams, and other locations requiring detection of overflow or flooding.

In addition, because Series 8041 Alarms will also operate from contact-type pilot devices, they are equally suitable for use in monitoring process variables such as temperature, pressure, flow, humidity, voltage and current, etc., as well as building security and fire detection alarms.

Installation is quick and easy with saddle clamp barrier terminal blocks for 12 to 18 gauge wire, or ring terminal connections to field wiring.

OPERATING FEATURES AND ADVANTAGES

BIW Series 8041 Alarm Systems also provide field-adjustable sensitivity from 1000 ohms up to 1 megohm to assure reliable operation over long distances and in detecting leaks or high levels of a wide variety of conductive liquids. A field adjustable time-delay is also provided to eliminate false trips due to liquid turbulence or electrical transients. The alarm action does not start until the time delay is completed.

Other features include: A SPDT auxiliary relay which has its coil energized when the process condition is normal so that its contact can be used to provide fail-safe remote signal, alarm or cut-off of pumps, valves, motors and other operating equipment in the event of a component or power failure. A holding circuit which permits operation over a range of levels or from momentary contact switching devices. Illuminated SILENCE and TEST pushbuttons and optional manual RESET button.

SINGLE ALARM PERFORMS MULTIPLE FUNCTIONS

Regardless of usage, however, a single alarm system may be applied with several electrodes or pilot devices connected in parallel to provide an audible alarm in the event a fault condition occurs at one or more of the remote detection points being monitored. Moreover, the low voltage and low current level of the sensing circuit permits use of low cost small gauge unshielded communication wires for long distance alarm installations.

BASIC SPECIFICATIONS:

Voltage:

Standard: 115 volts ac — 50/60 hertz
Optional: 230 volts ac — 50/60 hertz.
24 volts. dc.

Power Required:

- General Purpose Model 6 VA
- Industrial & Weatherproof with 6" Bell 11 VA
- with Horn 15 VA

Contact Rating: Single pole, double throw; 6 amperes resistive load at 120 volts ac.

Sensing Circuit: 24 volt dc and 0.5 milliamperes maximum. Sensitivity field adjustable from 1000 ohms up to 1 megohm.

Time Delay: Adjustable from 0 to 23 seconds.

Pushbuttons: SILENCE and TEST buttons are standard. RESET button is optional.

GENERAL PURPOSE MODEL

For indoor service in a steel enclosure with a solid state audible alarm.

INDUSTRIAL & WEATHERPROOF MODEL

For outdoor or indoor service in a fiberglass enclosure and with choice of a horn or a 6 inch bell.

DESCRIPTION OF OPERATION

STANDARD SEQUENCE is automatic reset with silence pushbutton and without lock-in, ISA designation A-1-4, with the extra feature of an adjustable time delay after the fault condition occurs which delays the alarm action for the set time period. The auxiliary SPDT contact is a fail safe arrangement that follows the alarm light status. The test pushbutton provides full operational test simulating an abnormal condition.

MANUAL RESET SEQUENCE operates the same as the standard sequence except that a momentary fault condition will lock-in the alarm status until the condition returns to normal, and the reset pushbutton is operated. The ISA sequence designation is M-1.

SEQUENCE TABLE

Line	Process Condition	Sensing Circuit Status	Operator Push Button Action			Alarm Status		Contact Status		Remarks
			Test	Silence	*Reset	Light	Audible	A	B	
1	Normal	Open	---	---	---	Off	Silent	Closed	Open	Line voltage — off
2	Normal	Open	---	---	---	Off	Silent	Open	Closed	Line voltage — on
3	Normal	Open	Push	---	---	Flashing	On	Closed	Open	Status goes to Line 4
4	Abnormal	Closed	---	---	---	Flashing	On	Closed	Open	Alarm occurs after time delay which is adjustable 0-23 seconds
5	Abnormal	Closed	---	Push	---	On	Silent	Closed	Open	
6	Normal	Open	---	---	---	Off	Silent	Open	Closed	Automatic Reset
*	Operation for Manual Reset Push Button Model		This option will lock-in a momentary abnormal condition at the status of line 4. After the condition returns to NORMAL, an operator action is required to reset alarm status. Line 6 is replaced by the following action.							Abnormal condition is locked-in
6A	Abnormal	Closed	---	---	Push	Flashing	On	Closed	Open	Status goes to Line 4 and must silence again
6B	Normal	Open	---	---	Push	Off	Silent	Open	Closed	

AMETEK®

PATRIOT SENSORS

TYPICAL APPLICATIONS

Diagrams below illustrate basic details of typical installations in which Series 8041 Alarm Systems are used to monitor and detect any off-normal conditions in applications involving the control of liquids and various common in-process variables.

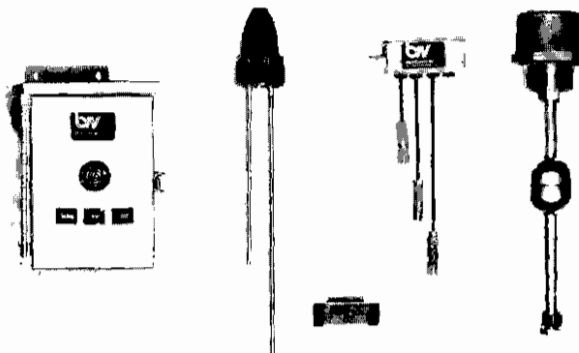

SUGGESTED CONTROL SETTINGS

Sensitivity: Set to a value greater than the specific resistance of the liquid to be controlled.

Time Delay: Normally 0-2 second or just long enough to prevent nuisance alarms resulting from wave action of the liquid.

In Diagram A, the system consists of one electrode set at the predetermined danger level and a second common electrode set at the same or a slightly lower level to complete the sensing circuit. In Diagram B, the jumper is removed from terminal block and a third reset electrode is used. The alarm will then go off automatically when liquid falls below the reset electrode. Diagram C is essentially the same except a normally-closed pushbutton is used to lock in alarm instead of a reset electrode. In Diagram D, a good ground return to the liquid is used to complete the sensing circuit instead of a common electrode.

OPERATION FROM ELECTRODES

Diagram A — High Level Alarm or Leak Detection System

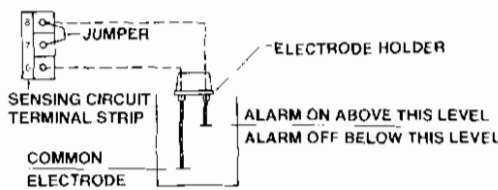

Diagram B — High Level Alarm or Leak Detection System with Automatic Reset Electrode

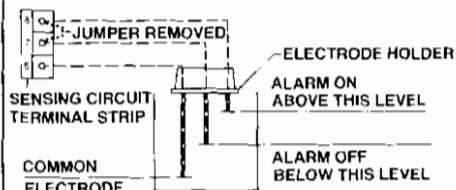

Diagram C — High Level Alarm or Leak Detection System with Lock-In and Reset Pushbutton

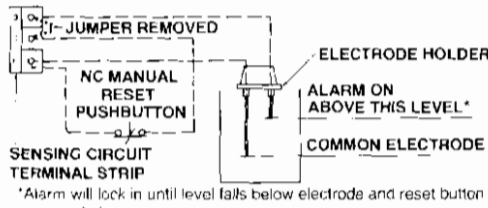
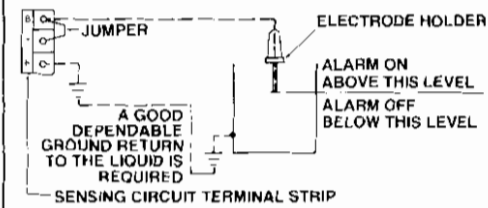

Diagram D — High Level Alarm Operated from Ground Return instead of Common Electrode



SUGGESTED CONTROL SETTINGS

Sensitivity: Normally set at minimum of 1000 ohm except when operating from a resistance transducer.

Time Delay: Normally 0-1 second or just long enough to prevent nuisance trips.

In Diagram E, the Series 8041 Alarm is used with a BIW Unifloat multiple switch level sensing assembly which can be applied to control any non-conductive or conductive liquid. In Diagram F, a remote pilot device is used to actuate the alarm in event of off-normal conditions such as temperature, smoke, pressure, flow, proximity, etc. Diagram G is similar except jumper at terminal block is removed and a normally closed pushbutton is used to lock in alarm. In Diagram H, a transducer that lowers resistance is used to sense any off-normal condition and trip the alarm.

OPERATION FROM PILOT SWITCHES

Diagram E — High Level Alarm System Operated from BIW Unifloat®

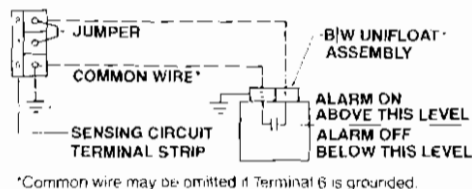
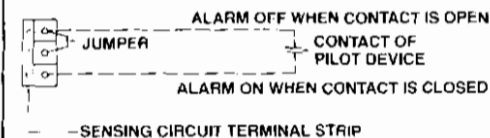

Diagram F — Process Alarm with Remote Pilot Switch Actuated by Off - Normal Conditions*



*Off-normal conditions may be temperature, smoke, pressure, humidity, flow, proximity, counter, voltage, current depending on type of pilot device used.

Diagram G — Security or Fire Alarm Operated from Pilot Device with Lock-In and Reset Button

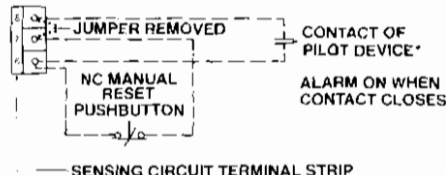
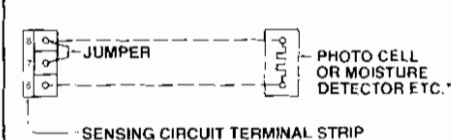
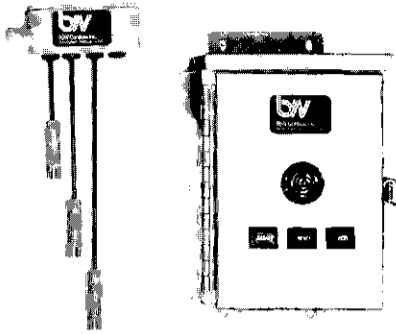

Diagram H — System with Device that Reduces Resistance when Actuated by Fault Condition



*Alarm sounds when sensing circuit resistance drops below sensitivity set point.

SOLID STATE ALARM PANELS



Series 8041 alarm system with the general purpose enclosure and a reset button shown with a conduit holder with wire suspension electrodes.

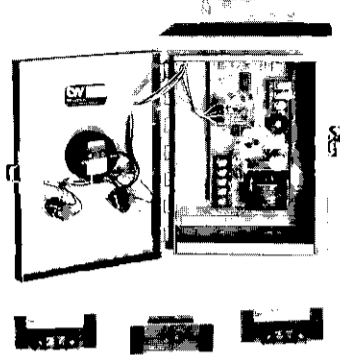

Series 8041 alarm system with the general purpose enclosure shown with BIW Moisture Sensors.

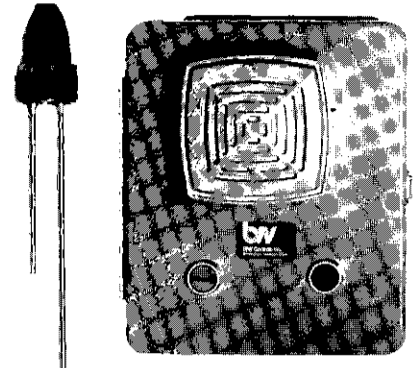

Series 8041 alarm system with the industrial enclosure shown with a molded electrode holder.

CATALOG NUMBERING SYSTEM AND LIST PRICES

SERIES 8041 ALARM SYSTEM WITH GENERAL PURPOSE NEMA 1 ENCLOSURE

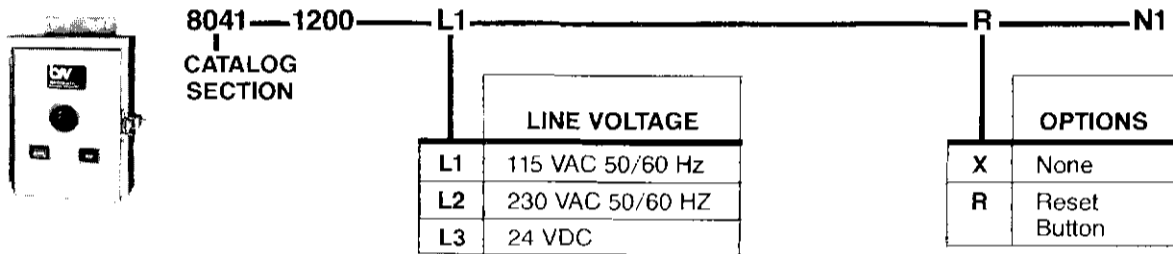

SERIES 8041 ALARM SYSTEM WITH INDUSTRIAL OR WEATHERPROOF ENCLOSURE

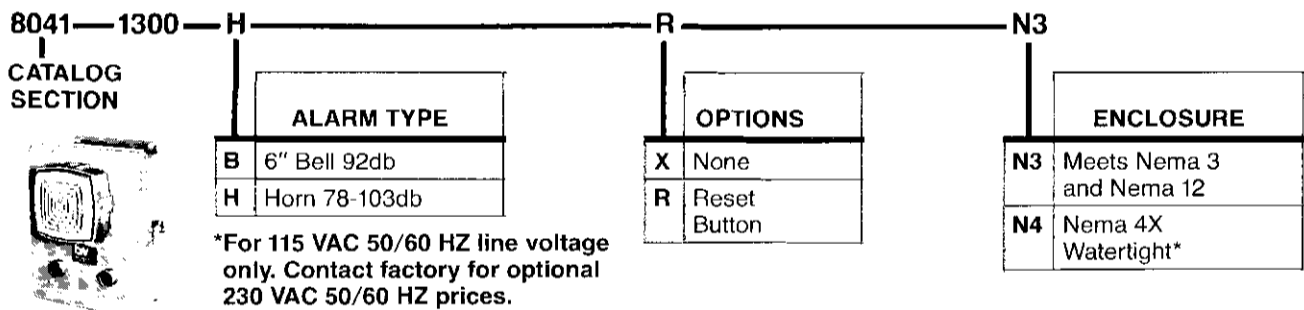

CONDUIT HUBS LIST PRICES

PVC HUBS — WITH O RING SEAL FOR PLASTIC CONDUIT



CONDUIT SIZE	PART NUMBER
½ INCH	04297400
¾ INCH	04297200

ALUMINUM HUBS — WITH GROUNDING SCREW FOR METAL CONDUIT



CONDUIT SIZE	PART NUMBER
½ INCH	04322400
¾ INCH	04263500

Field installation is simple using standard electrician's hole saw or punch.

METEK®

PATRIOT SENSORS

GENERAL PURPOSE MODEL

WIRING DIAGRAM

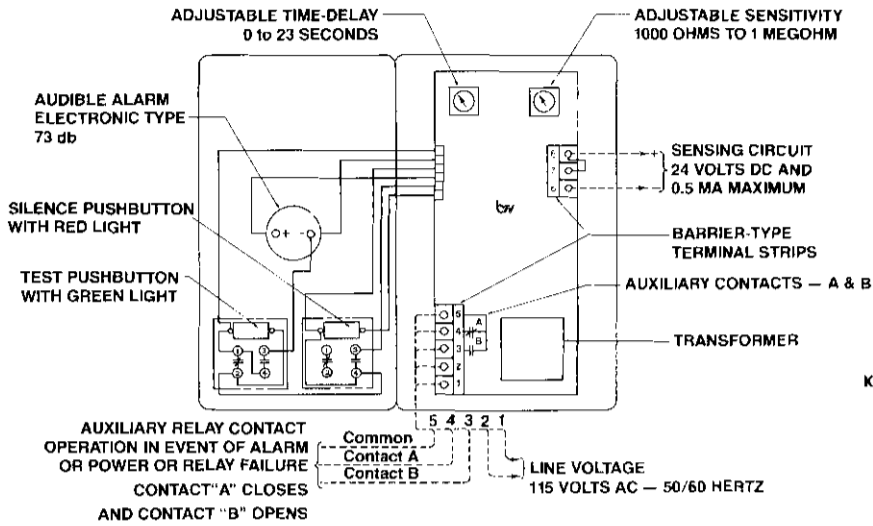

DIMENSIONS

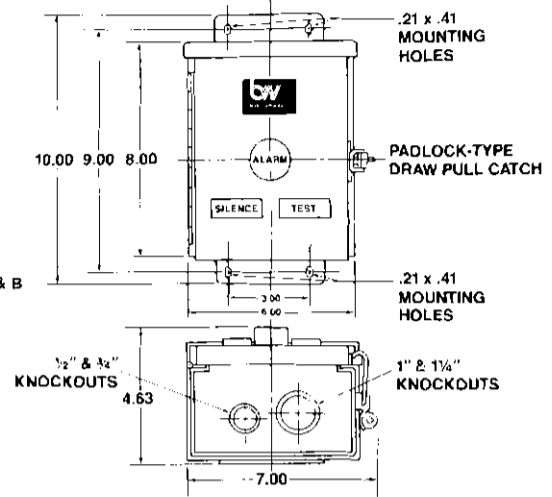

The General Purpose Enclosure is made of 16 ga. steel with gray baked enamel finish and is intended for indoor applications.

INDUSTRIAL AND WEATHERPROOF MODEL

WIRING DIAGRAM

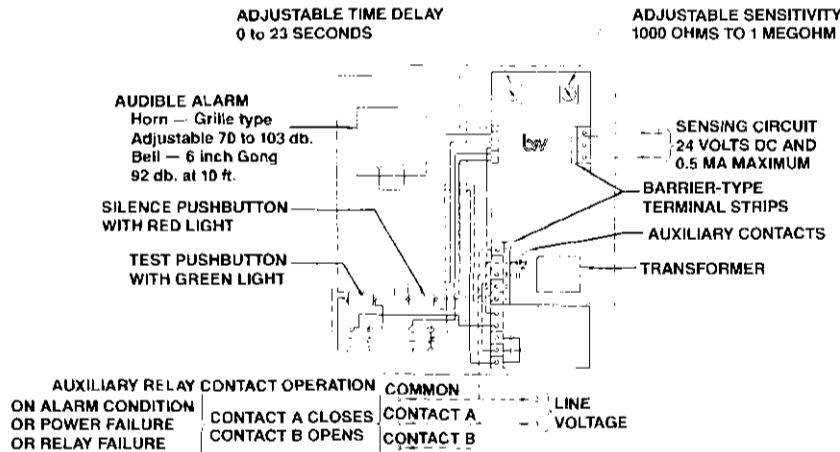

DIMENSIONS

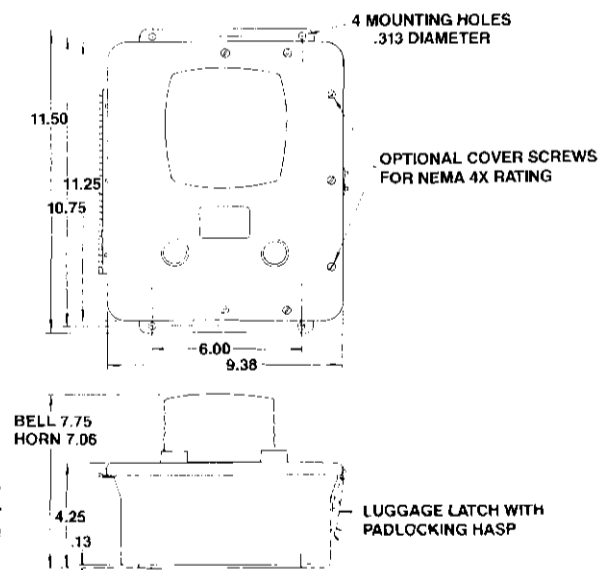

The enclosure is molded fiberglass in machine tool gray color with a closed cell neoprene cover gasket. It is rated NEMA 12 oiltight and dust-tight, and also meets NEMA 3 requirements for outdoor installation. The cover devices are watertight industrial quality. The stainless steel hinge and latch conform to NEMA 4X cor-

rosion resistance standards, however, in order to meet the severe NEMA 4 watertight hose test, screw cover fasteners are required rather than the luggage latch. This option is available and if required specify "NEMA 4X Watertight" when ordering.

NO CONDUIT OPENINGS ARE PROVIDED. CONDUIT HUBS ARE AVAILABLE FOR FIELD MOUNTING.